

Marcopia Round 7 - #3020



25W



2055lm



3000K



15°

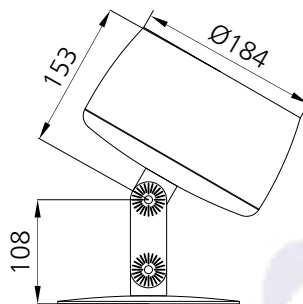
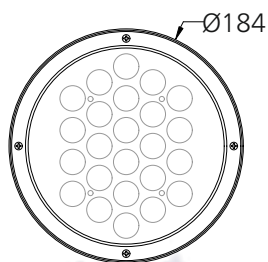

Photometric Data

Light source	LED - High Power	Light output ratio	73%
Power (W)	25W	Color rendering index (Ra)	>92
Delivered lumens	2055lm	Color rendering index (R9)	>50
Source lumens	2800lm	Binning MacAdam	<3 SDCM
Colour temperature (K)	3000K	LED life	L90 B10 Tj75°C
Luminaire efficacy	82.21lm/W	UGR	<19
Beam angle	15°	Operating temperature	-20°C to +50°C
Cutoff angle	NA	Light distribution	Direct - Symmetric

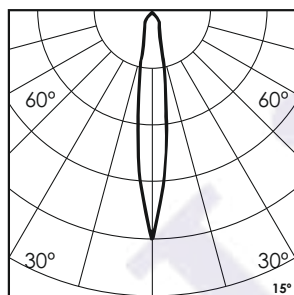

Technical Data

Mounting detail	Surface Uplighter	Heatsink material	Diecast alm.
Fixing detail	Cowl / Tree Strap / Pole Bracket / Mounting Plate	Product weight	3296gms
Orientation	Adjustable	Safety class	III
IP rating	IP65	Insulation class	III
IK rating	IK05	Voltage	AC230V / DC24V
Glow wire test	850°	Driver	In-built - AC230V Remote - DC24V

Photometric Graphs

Hue Bin vs Rf Graph

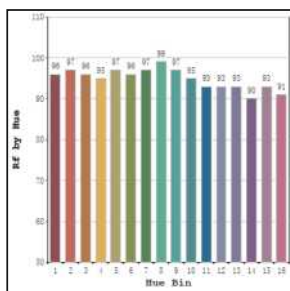

Color Vector Graph

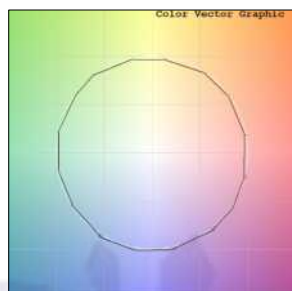

Spectrum vs Wavelength Graph

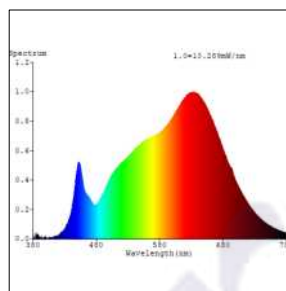

CIE Chromaticity Graph

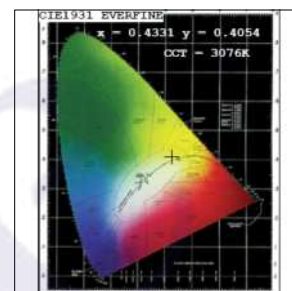

Finish Options

Body Finish

- Matt Grey
- Custom RAL Color

Filter Options



Honeycomb Filter

Above filters can be added to the fixture and need to be ordered as a separate accessory

Accessories Options



Cowl



Tree Strap



Pole Bracket

Above accessories can be added to the fixture and need to be ordered as a separate accessory

Dimming Options



Constant Voltage Driver
75w DC24V
Non Dimmable



Constant Voltage Driver
75w DC24V
Triac Dimmable



Constant Voltage Driver
75w DC24V
Analog 0-10V / 1-10V Dimmable



Constant Voltage Driver
75w DC24V
Dali Dimmable

L'azure constantly strives to improve our products using the latest technological advancements in the industry.
Due to which the data mentioned in the data sheet is subject to change without prior notice.